



Reheatable Packaging

Hot Case to Cold Case

Your one-stop shop for quality meal solution packaging



CONTENTS

With the explosive growth of ready-to-eat and grab-and-go meals, retailers need versatile packaging that can flex from hot to cold case to maximize impulse sales. This type of packaging fills a need for busy consumers who demand fresh pre-cooked meals that taste like homemade but can conveniently be reheated. Pactiv Evergreen is the one-stop shop for all reheatable packaging needs.



MealMaster® and EarthChoice® Rotisserie Chicken Containers

Whether you require a small or extra-large size, or a fully-microwavable EarthChoice package, Pactiv Evergreen has the largest depth and breadth of selection in chicken roasters. High-clarity domes with Fog Gard® coating and SmartVent™ technology ensure excellent product visibility in the hot or cold case for impulse sales.



MealMaster Chicken Barn Containers

A first-to-market innovative solution, chicken barns are designed to hold fried food with breading, keeping it crisp from store to door. SmartVent technology allows steam to vent, minimizing any condensation on the lid, for superior merchandising. The unique dimpling pattern on the base traps grease so that it does not come in contact with food. Maximize hot case sales with this exceptional packaging.



MealMaster and EarthChoice Rib Containers

These two-piece containers are designed to showcase cooked ribs and other entrées or side dishes by providing outstanding anti-fog technology coupled with a high-clarity dome for exceptional visual appeal. New EarthChoice polypropylene lids allow the total package to be microwaveable rather than just the base.



White MFPP Chicken and Rib Containers

White bases are now available for our classic two-piece mineral filled polypropylene (MFPP) chicken roasters, chicken barns and rib containers.



EarthChoice Dual-Color Vented Microwaveable Hinged Containers

Top-of-the-line containers in both appearance and performance! Great for the “gourmet prepared foods” counter at the local market or for restaurant curbside pickup, take-out or delivery. Fully microwaveable.



EarthChoice Hinged Lid Containers

EarthChoice Hinged Lid Containers are the clear choice for showcasing your hot and cold food items. Delivering operational excellence with their superb presentation and versatility, these containers are also microwave-safe.



Crisp2Go™ Dual-Color Vented Microwaveable Hinged Containers

Dual-color, extra-vented, microwaveable containers are optimally designed for performance and merchandising. These containers feature anti-fog and venting technology to keep food crisp. They are ideal for merchandising in hot case displays, warming units and under heat lamps.



Pro-Kal® Deli Containers

With six sizes and one common lid, these containers are great for “grab ‘n go” merchandising and takeout. These microwaveable containers have a high heat resistance and can handle your hottest foods. They are recyclable, lightweight and cost-effective. Combo packs are available.



Polypropylene (PP) SideKicks® Containers

SideKicks® Containers are portable and stackable, with a reliable, leak-resistant lid you can trust. These containers are perfect for everything from hot soups to cold salads. The one-size-fits-all lids are clear and vented, and both container and lid are microwave safe.



EarthChoice Entrée2Go™ Two-Piece Containers

Entrée2Go is the two-piece, to-go solution for supermarkets, takeout and delivery packaging needs. With a mineral-filled polypropylene (MFPP) base and a polypropylene (PP) lid, this container is both microwave and heat lamp safe.

Page
30



EarthChoice MFPP SmartLock® Hinged Containers

Perfect for to-go applications such as in-store hot bars or salad bars, EarthChoice MFPP SmartLock hinged containers are made from a mineral blended material that decreases the amount of plastic used in the product, reducing the environmental impact. This distinctive container offers exceptional temperature endurance and can be used for microwave reheating.

Page
32



EarthChoice Vented MFPP Microwaveable Hinged Containers

These highly-functional, low-cost, hinged containers are great for grocery store hot and cold bars or for restaurant curbside pickup and delivery. These microwaveable containers are a more cost-effective version of the EarthChoice MFPP SmartLock hinged container. They also have optional SmartVents to keep fried foods crisp.

Page
34



ClearView® MealMaster Two-Piece Containers

Pactiv Evergreen has the answer to grocers' needs for home meal replacement packaging for both hot and cold cases. These versatile, two-piece containers have a base that is made with a blended mineral material that reduces the amount of plastic used in the product, promoting sustainability. The bases are also microwave-safe, making reheating convenient.

Page
37



EarthChoice ClearView® MealMaster Two-Piece Containers

White bases are now available for our classic MealMaster Two-Piece Containers. A versatile option, ideal for home meal replacement packaging in grocery store hot and cold cases, while also stylish and functional for restaurant takeout and delivery.



ClearView MicroMax® Two-Piece Oval and Rectangle Containers

Micromax two-piece containers offer a more economical solution for home meal replacement. Unique oval containers are perfect to showcase sides or casserole dishes. Rectangular shapes are offered as well. Both shapes have microwaveable bases.



Newspring Containers and Portion Cups

Top-of-the-line in both performance and presentation, VERSAtainer®, DELItainer®, and Ellipso® containers are stackable, leak resistant and microwavable.



EarthChoice Versa2Go Microwaveable Containers

Featuring a unique matte finish, these leak-resistant containers are a sustainable solution for all your delivery and takeout needs. For leftovers, these containers easily go from refrigerator to microwave to dishwasher, for multi-purpose use.



Classic Carryout Containers

Attractive, versatile and ovenable, classic carryout containers offer an upscale image for any home meal replacement program.



Pressware® Dual-Ovenable Paperboard Containers and Pizza Trays

The versatility of Pressware dual-ovenable paperboard cannot be beat! Pressware is available in a variety of colors and sizes for microwave or oven applications and can even be frozen! Customizable options and special print available to suit all processor needs.



Rotisserie Chicken Containers

Our chicken roaster packaging solutions offer multiple sizes and materials to meet your merchandising needs!

Venting

Built-in venting system allows steam to release, keeping food hot, juicy and delicious.

Superior visibility

Dome lids feature excellent visibility without condensation due to anti-fog technology. For optimal clarity, choose our oriented polystyrene (OPS) domes.

Reduced environmental impact

EarthChoice® mineral filled polypropylene (MFPP) bases are made with 50% less plastic than traditional polypropylene (PP) containers, reducing fossil fuel based material usage. PP dome lids are recyclable in the communities that accept these products. Check locally.

Versatile merchandising

Containers are suitable for both hot and cold applications, reducing operator SKU's and increasing efficiencies. Multiple sizes and materials are available for all chicken roaster needs.

High heat performance

Rotisserie Chicken Containers are suitable for merchandising in hot case displays, warming units and under heat lamps. EarthChoice MFPP bases and PP lids are also suitable for reheating in a microwave.

Transport with confidence

Our ZipSeal™ Closure System's leak-resistant seal keeps package contents secure during transport. The easy to apply lid has an audible snap indicating the lid has been sealed.



Rotisserie Chicken Containers

Product specifications

Product number	Brand	Description	Dimensions (in.)	Capacity (oz.)	Size	Material	Color	Case pack	Case cube (ft ³)	Gross case weight (lbs.)
YCNC60030LDZ	Pactiv Evergreen	Chicken roaster label panel combo	10.8 x 8.5 x 4.3	50.0	XL	MFPP/OPS	Black base/ Clear lid	95	2.0	14.6
YCNC600800DZE	Pactiv Evergreen	Chicken roaster Zip dry combo	10.0 x 7.0 x 4.5	50.0	M/L	MFPP/OPS	Black base/ Clear lid	100	2.0	13.1
YCNC600700DZ	Pactiv Evergreen	Chicken roaster Smart Vent Zip dry combo	10.0 x 7.5 x 4.0	41.6	M	MFPP/OPS	Black base/ Clear lid	110	2.3	14.6
YCNC690700DZ	Pactiv Evergreen	Chicken roaster with handle combo	12.5 x 8.6 x 4.3	41.6	M	MFPP/OPS	Black base/ Clear lid	110	2.7	17.4
YCNC600500DZ	Pactiv Evergreen	Chicken roaster 4 hole vent Zip dry combo	10.0 x 7.5 x 4.0	41.6	M	MFPP/OPS	Black base/ Clear lid	110	2.3	14.7
YCNC600500DW	Pactiv Evergreen	Chicken roaster 4 hole vent combo	10.0 x 7.5 x 4.0	41.6	M	MFPP/OPS	White base/ Clear lid	110	2.3	16.2
YCNC6003LDPPZ	EarthChoice	Chicken roaster label panel combo	10.5 x 8.3 x 4.9	50.0	XL	MFPP/PP	Black base/ Clear lid	90	2.3	14.3
YCNC6007DPPZ	EarthChoice	Chicken roaster vent combo Zip	10.0 x 7.5 x 4.0	41.6	M	MFPP/PP	Black base/ Clear lid	95	2.3	12.0
YCNC6011DPPZ	EarthChoice	Chicken roaster combo	9.5 x 7.5 x 4.3	47.0	S	MFPP/PP	Black base/ Clear lid	80	1.7	11.3

What temperature range is recommended?

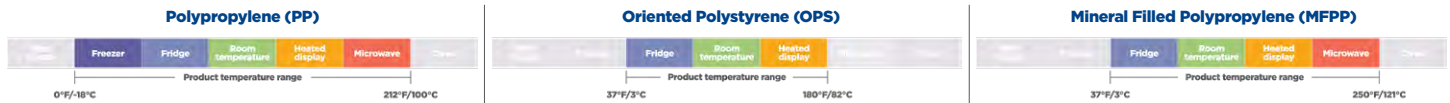

Virtual Packaging Assistant

The Virtual Packaging Assistant (VPA) app can be used for all of your Foodservice Packaging Solutions! It is available for download on all Apple, Android and Windows devices.

These guidelines are supplied to assist you in determining the proper use of Pactiv Evergreen products. They are based upon testing and published guidelines and are reliable in most applications. However, because every food supplier's recipes, ingredients, processes and supply chain is unique, these guidelines are not a substitute for product testing. Confirmation of product acceptability under your specific conditions of use must be done by you.





ClearView™ MealMaster™ **Chicken Barn Containers**

Maximize hot case sales with containers that are ideal for crispy, fried, hot food.



Keep it crispy

Built-in venting system allows steam to release, keeping food hot, crispy and delicious. Vents are even functional when stacked!

High heat performance

Chicken Barns are suitable for merchandising in hot case displays, warming units and under heat lamps. MFPP bases are also suitable for reheating in a microwave.

Functional design

Channels in the container bottom allow air to circulate around food while wells within the channels collect moisture and grease. Ribbed sidewalls offer superior strength and crush resistance.

Superior visibility

Dome lids feature excellent visibility without condensation due to a robust venting system.

Transport with confidence

SmartTote™ handles provide a convenient carryout experience increasing customer satisfaction.





ClearView™ MealMaster™ Chicken Barn Containers



OCNC30020000



OCNC300200NH



YCNC30040000



YCNC300400NH



YCNC300800NH



YCNC3008NHHALFV



OCNC30160000

Product specifications

Product number	Brand	Description	Dimensions (in.)	Capacity	Size	Material	Color	Case pack	Case cube (cu. ft.)	Gross case weight (lbs.)
OCNC30020000	Clearview™ MealMaster™	Chicken Barn 2PC Combo	7.6 x 6.6 x 3.3	2 PC	S	MFPP/OPS	Black/Clear	200	1.1	14.7
OCNC300200NH	Clearview™ MealMaster™	Chicken Barn 2PC No Handle Combo	7.6 x 6.6 x 3.3	2 PC	S	MFPP/OPS	Black/Clear	200	2.4	14.6
YCNC30040000	Clearview™ MealMaster™	Chicken Barn 4PC Combo	9.5 x 8 x 3	4 PC	S	MFPP/OPS	Black/Clear	100	2.2	11.1
YCNC300400NH	Clearview™ MealMaster™	Chicken Barn 4PC No Handle Combo	9.5 x 8 x 3	4 PC	M	MFPP/OPS	Black/Clear	100	2.3	12.9
YCNC300800NH	Clearview™ MealMaster™	Chicken Barn 8PC No Handle Combo	13.3 x 8.4 x 4	8 PC	M	MFPP/OPS	Black/Clear	105	3.3	20.4
YCNC3008NHHALFV	Clearview™ MealMaster™	Chicken Barn 8PC No Handle Half Vented Combo	13.3 x 8.4 x 4	8 PC	M	MFPP/OPS	Black/Clear	105	3.3	21.4
OCNC30160000	Clearview™ MealMaster™	Chicken Barn 16PC Combo	14 x 10.5 x 4	16 PC	L	MFPP/OPS	Black/Clear	50	2.1	13.9

What temperature range is recommended?



These guidelines are supplied to assist you in determining the proper use of Pactiv Evergreen products. They are based upon testing and published guidelines and are reliable in most applications. However, because every food supplier's recipes, ingredients, processes and supply chain is unique, these guidelines are not a substitute for product testing. Confirmation of product acceptability under your specific conditions of use must be done by you.





Rib Containers

Showcase ribs, entrées, meal kits and other foods to-go with Pactiv Evergreen's rib containers!

Transport with confidence

Our ZipSeal™ Closure System's leak-resistant seal keeps package contents secure during transport. The easy to apply lid has an audible snap indicating the lid has been sealed.

Superior visibility

Dome lids feature excellent visibility without condensation due to anti-fog technology. For optimal clarity, choose our oriented polystyrene (OPS) domes.

Versatile merchandising

Containers are suitable for both hot and cold applications, reducing operator SKUs and increasing efficiency.

Reduced environmental impact

EarthChoice® mineral filled polypropylene (MFPP) bases are made with 50% less plastic than traditional polypropylene (PP) containers, reducing fossil fuel based material usage. PP dome lids are recyclable in the communities that accept these products. Check locally.

High heat performance

Rib containers are suitable for merchandising in hot case displays, heat lamps and warming units. EarthChoice MFPP bases and PP lids are also suitable for reheating in a microwave.



Rib Containers

Product specifications

Product number	Brand	Description	Dimensions (in.)	Capacity (oz.)	Material	Color	Case pack	Case cube (ft ³)	Gross case weight (lbs.)	Tier/height
OCNC10700DZY	MealMaster	Rib half slab rib-zip combo	10.0 x 7.1 x 2.1	34.3	MFPP/OPS	Black base/ Clear lid	90	2.5	11.0	11/2
YCNC167000DZ	MealMaster	Rib full slab rib-zip combo	16.6 x 7.3 x 2.3	41.9	MFPP/OPS	Black base/ Clear lid	80	3.4	14.7	5/3
YCNC1670HDDZ	MealMaster	Rib full slab rib-zip combo with high dome	16.6 x 7.3 x 3	41.9	MFPP/OPS	Black base/ Clear lid	70	3.1	12.9	6/3
YCNC1070DPPZ	EarthChoice	Rib half slab rib-zip combo	10.8 x 7.1 x 2.1	34.3	MFPP/PP	Black base/ Clear lid	90	2.5	12.5	11/2
YCNC1670DPPZ	EarthChoice	Rib full slab rib-zip combo	16.6 x 7.1 x 2.1	41.9	MFPP/PP	Black base/ Clear lid	80	3.4	17.2	5/3

What temperature range is recommended?



Virtual Packaging Assistant

The Virtual Packaging Assistant (VPA) app can be used for all of your Foodservice Packaging Solutions! It is available for download on all Apple, Android and Windows devices.

These guidelines are supplied to assist you in determining the proper use of Pactiv Evergreen products. They are based upon testing and published guidelines and are reliable in most applications. However, because every food supplier's recipes, ingredients, processes and supply chain is unique, these guidelines are not a substitute for product testing. Confirmation of product acceptability under your specific conditions of use must be done by you.





White MFPP **Chicken and Rib Containers**

White bases are now available for our classic two-piece mineral filled polypropylene (MFPP) chicken roasters, chicken barns and rib containers.

Reduced environmental impact

Mineral filled polypropylene (MFPP) bases are made with 50% less plastic than traditional PP containers, reducing fossil fuel-based material usage.

Versatile merchandising

Containers are suitable for both hot and cold applications, reducing operator SKUs and increasing efficiencies. These containers are suitable for use in hot case displays, warming units and under heat lamps.

Keep it crispy

Built-in venting system allows steam to release, keeping food hot and crispy.

Transport with confidence

Our ZipSeal™ Closure System's leak-resistant seal keeps package contents secure during transport. The easy to apply lid has an audible snap indicating the lid has been sealed.





White MFPP Chicken and Rib Containers

Product specifications

Product number	Brand	Description	Dimensions (in.)	Material	Color	Case pack
OCNC3002000W	Pactiv Evergreen	2 piece chicken barn combo pack	7.6 x 6.6 x 3.3	MFPP/OPS	White/Clear	200
YCNC3004000W	Pactiv Evergreen	4 piece chicken barn combo pack	9.5 x 8 x 3	MFPP/OPS	White/Clear	100
YCNC30080NHW	Pactiv Evergreen	8 piece chicken barn combo pack	13.3 x 8.4 x 4	MFPP/OPS	White/Clear	105
YCNC600500DW	Pactiv Evergreen	Chicken roaster with dome lid	10 x 7.5 x 4	MFPP/OPS	White/Clear	110
YCNC60070DZW	Pactiv Evergreen	Chicken roaster with dome lid	10 x 7.5 x 4	MFPP/OPS	White/Clear	110
YCN6007WDPZ	Pactiv Evergreen	Chicken roaster with dome lid	10 x 7.5 x 4	MFPP/PP	White/Clear	95
YCNC16700DZW	Pactiv Evergreen	Full rib container with dome lid	16.6 x 7.3 x 2.3	MFPP/OPS	White/Clear	80
YCNC167HDDZW	Pactiv Evergreen	Full rib container with dome lid	16.6 x 7.3 x 2.3	MFPP/OPS	White/Clear	70
OCNC1070DZYW	Pactiv Evergreen	Half rib container with dome lid	10 x 7.1 x 2.1	MFPP/OPS	White/Clear	90
YCN1070WDPZ	Pactiv Evergreen	Half rib container with dome lid	10 x 7.1 x 2.1	MFPP/PP	White/Clear	90

What temperature range is recommended?

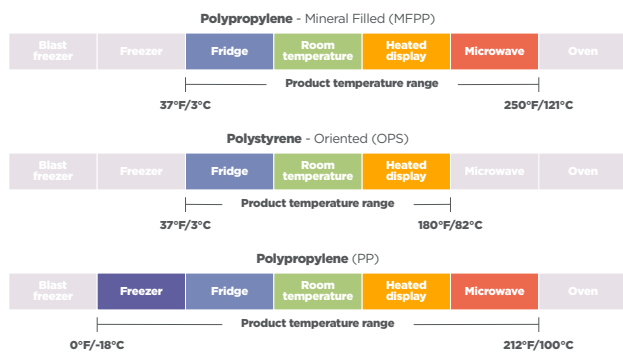

Virtual Packaging Assistant

The Virtual Packaging Assistant (VPA) app can be used for all of your Foodservice Packaging Solutions! It is available for download on all Apple, Android and Windows devices.

These guidelines are supplied to assist you in determining the proper use of Pactiv Evergreen products. They are based upon testing and published guidelines and are reliable in most applications. However, because every food supplier's recipes, ingredients, processes and supply chain is unique, these guidelines are not a substitute for product testing. Confirmation of product acceptability under your specific conditions of use must be done by you.





Dual-Color Hinged Lid Containers

We've added innovative Crisp2Go™ solutions to our top of the line EarthChoice® Dual-Color Hinged Lid Container family. Check out these new SKUs for your crispy and crunchy menu items.



Dual-Color Hinged Lid Containers

Premium performance

These containers are strong, stackable, and moisture resistant so they can stand up to hearty and saucy foods. The Zip Seal™ closure provides superior leak resistance for deliver and takeout.



Upscale presentation

The black bases offer an elegant backdrop for your colorful menu items, while the clear lids provide easy order identification reducing mix ups when packing to-go bags.

Keep food crispy

The SmartVent™ technology, allows steam to release, keeping food hot and crispy. Our Crisp2Go™ SKUs feature additional top and side vents that help to keep food crisp and hot even while stacked in a bags.



Dual-Color Hinged Lid Containers

High heat performance

These containers are ideal for merchandising in hot case displays and to-go staging under heat lamps. Also, suitable for reheating in a microwave and top rack residential dishwasher safe.



Enhanced eating experience

The hinged lid features a perforated tear, allowing the lid to be removed from the base for an improved consumer experience. The lid is resealable as a two-piece container for storage.

What temperature range is recommended?

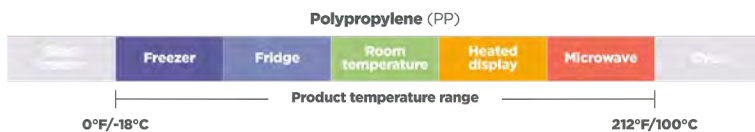



Product Line

Product number	Brand	Description	Dimensions (in.)	Capacity (oz.)	Material	Color	Case pack
DC6610B0XV	EarthChoice Crisp2Go	6 x 6" Single compartment, 1-compartment lid, with extra venting	6.3 x 6.2 x 3.2	16	PP	Clear lid/ Black base	225
DC961000B0XV	EarthChoice Crisp2Go	9 x 6" Single compartment, 1-compartment lid, with extra venting	9 x 6.3 x 3.3	34	PP	Clear lid/ Black base	140
DC1091WDB000	EarthChoice Crisp2Go	10.5 x 9.5" Extra vented 1-compartment base, 1-compartment lid hinged container	10.5 x 9.5 x 3.1	61	PP	Clear lid/ Black base	144
DC6610B000	EarthChoice	6 x 6" Vented 1-compartment base, 1-compartment lid hinged container	6 x 6 x 3.1	16	PP	Clear lid/ Black base	320
DC757100B000	EarthChoice	7.5 x 7.5" Vented 1-compartment base, 1-compartment lid hinged container	7.5 x 7.5 x 3.1	28	PP	Clear lid/ Black base	150
DC961000B000	EarthChoice	9 x 6" 1-compartment base, 1-compartment lid hinged container	9 x 6 x 3.1	34	PP	Clear lid/ Black base	140
DC962200B000	EarthChoice	9 x 6" 2-compartment base, 2-compartment lid hinged container	9 x 6 x 3.1	20/12	PP	Clear lid/ Black base	140
DC858100B000	EarthChoice	8.5 x 8.5" Vented 1-compartment base, 1-compartment lid hinged container	8.5 x 8.5 x 3.1	38	PP	Clear lid/ Black base	150
DC858310B000	EarthChoice	8.5 x 8.5" 3-compartment base, 1-compartment lid hinged container	8.5 x 8.5 x 3.1	21/6/6	PP	Clear lid/ Black base	150
DC858330B000	EarthChoice	8.5 x 8.5" Vented 3-compartment base, 3-compartment lid hinged container	8.5 x 8.5 x 3.1	21/6/6	PP	Clear lid/ Black base	150
DC109100B000	EarthChoice	10.5 x 9.5" Vented 1-compartment base, 1-compartment lid hinged container	10.5 x 9.5 x 3.1	61	PP	Clear lid/ Black base	132
DC109310B000	EarthChoice	10.5 x 9.5" Vented 3-compartment base, 1-compartment lid hinged container	10.5 x 9.5 x 3.1	34/10/10	PP	Clear lid/ Black base	132
DC109330B000	EarthChoice	10.5 x 9.5" Vented 3-compartment base, 3-compartment lid hinged container	10.5 x 9.5 x 3.1	34/10/10	PP	Clear lid/ Black base	132



Scan to watch and learn more about EarthChoice Crisp2Go™

Learn about how the EarthChoice Crisp2Go™ technology works to keep hot foods crispy and delicious from store to door.



These guidelines are supplied to assist you in determining the proper use of Pactiv Evergreen products. They are based upon testing and published guidelines and are reliable in most applications. However, because every food supplier's recipes, ingredients, processes and supply chain is unique, these guidelines are not a substitute for product testing. Confirmation of product acceptability under your specific conditions of use must be done by you.





Polypropylene Hinged Lid Containers

EarthChoice® Hinged Lid Containers are the clear choice for showcasing your hot and cold food items. Delivering operational excellence with their superb presentation and versatility.



Recyclable

EarthChoice® polypropylene containers are recyclable. Recycling products gives them a second life and helps keep them out of landfills.

Superior visibility

The all clear design showcases your menu items and makes for easy order identification reducing mix ups when packing to-go bags.

Keep it crispy

The SmartVent™ system allows steam to release, keeping food hot and crispy even on the go.

Premium performance

These containers are strong, stackable, and moisture resistant so they can stand up to hearty and saucy foods. The Zip Seal™ closure provides superior leak resistance for deliver and takeout.

Consumer convenience

Consumers will appreciate that these containers are microwaveable and are safe for top rack use in residential dishwashers.



Polypropylene Hinged Lid Containers

Product specifications

Product number	Brand	Description	Dimensions (in.)	Capacity (oz.)	Material	Color	Case Pack
CC6610PP	EarthChoice	6 x 6" 1-Compartment hinged lid containers	6 x 6 x 3	16	PP	Clear	321
CC858100PP	EarthChoice	8.5 x 8.5" 1-Compartment hinged lid containers	8.5 x 8.5 x 3	38	PP	Clear	150
CC858330PP	EarthChoice	8.5 x 8.5" 3-Compartment hinged lid containers with 3-compartment lid	8.5 x 8.5 x 3	21/6/6	PP	Clear	150
CC9610PP	EarthChoice	9 x 6" 1-Compartment hinged lid containers	9 x 6 x 3	34	PP	Clear	140
CC109100PP	EarthChoice	10.5 x 9.5" 1-Compartment hinged lid containers	10.5 x 9.5 x 3.6	61	PP	Clear	132
CC109330PP	EarthChoice	10.5 x 9.5" 3-Compartment hinged lid containers with 3-compartment lid	10.5 x 9.5 x 3.6	34/10/10	PP	Clear	132

What temperature range is recommended?

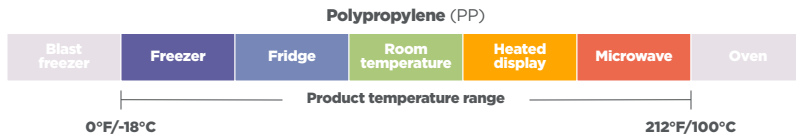

Virtual Packaging Assistant

The Virtual Packaging Assistant (VPA) app can be used for all of your Foodservice Packaging Solutions! It is available for download on all Apple, Android and Windows devices.



These guidelines are supplied to assist you in determining the proper use of Pactiv Evergreen products. They are based upon testing and published guidelines and are reliable in most applications. However, because every food supplier's recipes, ingredients, processes and supply chain is unique, these guidelines are not a substitute for product testing. Confirmation of product acceptability under your specific conditions of use must be done by you.





Polypropylene **Crisp2Go™ Hinged Lid Containers** Dual-color extra-vented microwaveable containers

Optimally designed for performance and merchandising, these containers are great for supermarket self-serve hot bars, keeping food crispy and delicious from store to door.

Keep it crispy

Featuring innovative side venting and SmartVent™ technology, optimally placed vents allow steam to release keeping food crisp and hot even while stacked in a bag.

High heat performance

Dual-color hinged lid Polypropylene (PP) containers are ideal for merchandising in hot case displays, warming units and under heat lamps. Also, suitable for reheating in a microwave and top rack residential dishwasher safe.

Superior visibility

Clear hinged dome lids feature excellent visibility without condensation due to anti-fog technology, increasing impulse sales.

Great for grab-and-go

Containers are stackable with ease and fit together well in commonly used bags. Designed with ribbing which offers superb strength to handle the hardest prepared foods.

Enhanced eating experience

The hinged lid features a perforated tear, allowing the lid to be removed from the base for an improved consumer experience. The lid is resealable as a two-piece container for storage.



How do Crisp2Go™ Hinged Lid Containers keep food hot and crispy?

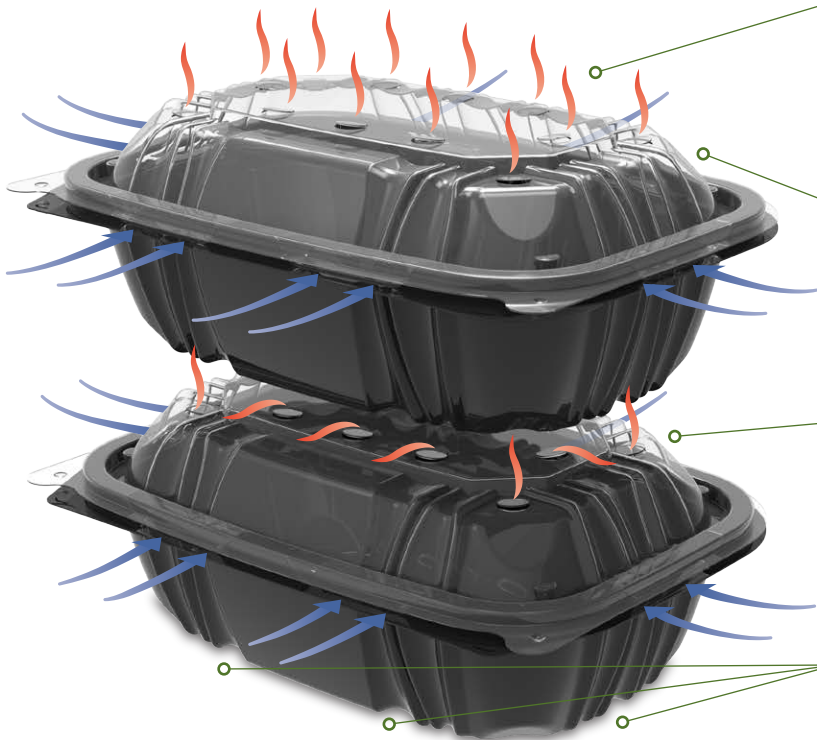

SmartVent™ technology

Top and corner c-vents open up as pressure builds allowing steam to escape.

Anti-fog coating

Reduces condensation build up and resulting droplets on the interior of the lid.

Venting while stacked

Corner c-vents provide unrestricted airflow when containers are stacked together on display or in a bag.

Air channels

Built-in air channels allow steam from top c-vents to escape while containers are stacked.

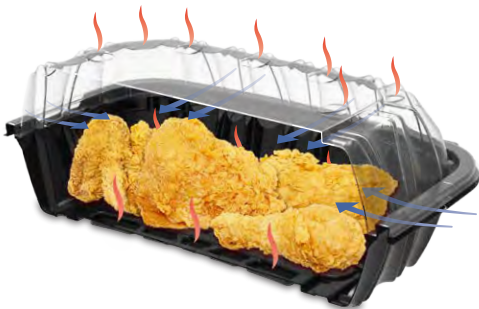

Cross ventilation design

Venting air paths eliminate hot moist air while minimizing the food heat loss.



Base bottom design

Channels in bottom allow air to circulate around food while wells within the channels collect moisture and grease.



Side seal venting

Cool dry air enters in through side seal venting which helps to maintain the crispiness of the food.



Crisp2Go™ Hinged Lid Containers

Dual-color extra-vented microwaveable containers

Product specifications

Product number	Description	Dimensions (in.)	Capacity (oz.)	Material	Color	Case pack	Case cube (ft³)	Gross case weight (lbs)	Tier/height
DC6610BOXV	6 x 6 Single compartment, 1-compartment lid, with extra venting	6.3 x 6.2 x 3.2	16	PP	Black base/ Clear lid	225	3.6	16.3	4 x 3
DC961000BOXV	9 x 6 Single compartment, 1-compartment lid, with extra venting	9 x 6.3 x 3.3	34	PP	Black base/ Clear lid	140	3.3	16.2	6 x 2
DC1091WDB000	10.5 x 9.5 Single compartment, 1-compartment lid, with extra venting	10.5 x 9.5 x 3.1	61	PP	Black base/ Clear lid	144	6.0	27.4	4 x 2

*Clear/Clear available as made to order (MTO)



What temperature range is recommended?

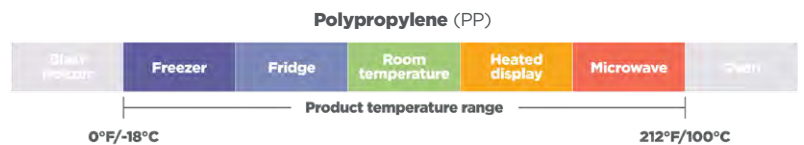

Scan to watch and learn more about EarthChoice Crisp2Go™

Learn about how the EarthChoice Crisp2Go™ technology works to keep hot foods crispy and delicious from store to door.



These guidelines are supplied to assist you in determining the proper use of Pactiv Evergreen products. They are based upon testing and published guidelines and are reliable in most applications. However, because every food supplier's recipes, ingredients, processes and supply chain is unique, these guidelines are not a substitute for product testing. Confirmation of product acceptability under your specific conditions of use must be done by you.



FK® Fabri-Kal®

Pro-Kal® Deli Containers

With six sizes and one common lid these containers are great for grab 'n go merchandising and transporting take-out!



Economical

Contact-clear Pro-Kal® containers are your solution for a lightweight, cost-effective package.

Excellent Temperature Endurance

These microwaveable containers have a high heat resistance and can handle your hottest foods.

Recyclable

Recycling products gives them a second life.

Efficient for Inventory

One lid fits six containers. Combo packs available for convenience and operational simplicity.



Pro-Kal[®] Deli Containers

Containers

Product Number	Fabri-Kal #	Brand	Description	Dimensions (In.)	Capacity	Material	Case Qty.	Lid
9505274	PK5S-C	Fabri-Kal	5 oz. Clear, deli containers	3.6 x 2.6 x 1.8	5	PP	1,000	LKC12/20F DLKC12/20NH
9505531	PK6S-C	Fabri-Kal	6 oz. Clear, deli containers	4.6 x 4.0 x 1.3	6	PP	500	PPLID, PELIDFLSH
9505100	PK8S-C	Fabri-Kal	8 oz. Clear, deli containers	4.6 x 3.9 x 1.7	8	PP	500	PPLID, PELIDFLSH
9505114	PK12S-C	Fabri-Kal	12 oz. Clear, deli containers	4.6 x 3.7 x 2.3	12	PP	500	PPLID, PELIDFLSH
9505102	PK16S-C	Fabri-Kal	16 oz. Clear, deli containers	4.6 x 3.5 x 3.0	16	PP	500	PPLID, PELIDFLSH
9505103	PK24T-C	Fabri-Kal	24 oz. Clear, deli containers	4.6 x 3.7 x 4.1	24	PP	500	PPLID, PELIDFLSH
9505104	PK32T-C	Fabri-Kal	32 oz. Clear, deli containers	4.6 x 3.4 x 5.6	32	PP	500	PPLID, PELIDFLSH
9505496	PK8C Combo	Fabri-Kal	8 oz. Clear, deli containers and lids, combo pack	4.6 x 3.9 x 1.7	8	PP	250	PPLID
9505497	PK16C Combo	Fabri-Kal	16 oz. Clear, deli containers and lids, combo pack	4.6 x 3.5 x 3.0	16	PP	250	PPLID
9505498	PK32C Combo	Fabri-Kal	32 oz. Clear, deli containers and lids, combo pack	4.6 x 3.4 x 5.6	32	PP	250	PPLID



Pro-Kal® Deli Containers

Lids

Product Number	Fabri-Kal #	Brand	Description	Dimensions (In.)	Material	Color	Case Qty.
9505466	PPLID	Fabri-Kal	Plug-fit lids for deli containers	4.7 x 0.3	PP	Clear	500
9505261	PELIDFLSH	Fabri-Kal	Flush fill lids for deli containers	4.6 x 0.3	PE	Translucent	500
9508056	LKC12/20F	Fabri-Kal	Flat lids with no hole for deli containers	3.8 x 0.3	PET	Clear	1,000
9508059	DLKC12/20NH	Fabri-Kal	Dome lids with no hole for deli containers	3.8 x 1.6	PET	Clear	1,000

What temperature range is recommended?

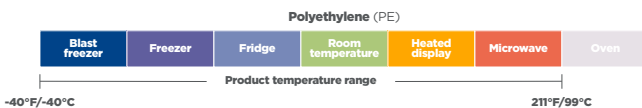
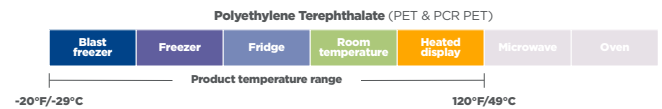
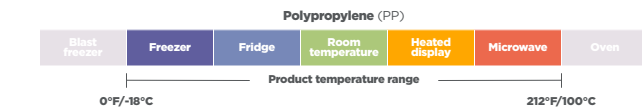

Virtual Packaging Assistant

The Virtual Packaging Assistant (VPA) app can be used for all of your Foodservice Packaging Solutions! It is available for download on all Apple, Android and Windows devices.



These guidelines are supplied to assist you in determining the proper use of Pactiv Evergreen products. They are based upon testing and published guidelines and are reliable in most applications. However, because every food supplier's recipes, ingredients, processes and supply chain is unique, these guidelines are not a substitute for product testing. Confirmation of product acceptability under your specific conditions of use must be done by you.





Polypropylene SideKicks® Containers

Performance on-the-go

SideKicks® Containers are portable and stackable, with a reliable, leak-resistant lid you can trust. Ideal for prepared foods, takeout, and delivery—and ready to hold whatever you put in them.

Efficient and versatile

These containers are perfect for everything from hot soups to cold salads. One-size fits all lids are clear and vented, and both container and lid are microwave safe.

High style, high function

A striking, upscale look showcases your sides. And a convenient wide-mouth design makes SideKicks® Containers spoonable, dippable, and supremely snackable.

Product specifications

Product number	Brand	Description	Dimensions (in.)	Capacity (oz.)	Material	Color	Case pack
FC4B 9507201	Fabri-Kal	SideKicks 4 oz. round containers	4.7 x 2.7 x 1.3	4	PP	Black	750
FC6B 9507202	Fabri-Kal	SideKicks 6 oz. round containers	4.7 x 2.7 x 1.6	6	PP	Black	750
FC8B 9507203	Fabri-Kal	SideKicks 8 oz. round containers	4.7 x 2.7 x 2	8	PP	Black	750
FC12B 9507207	Fabri-Kal	SideKicks 12 oz. round containers	4.7 x 2.6 x 2.8	12	PP	Black	750
FC16B 9507208	Fabri-Kal	SideKicks 16 oz. round containers	4.7 x 2.6 x 3.4	16	PP	Black	500
LFC 9507205	Fabri-Kal	Vented lids for SideKicks containers	4.7 x 0 x 0.6	-	PP	Clear	750

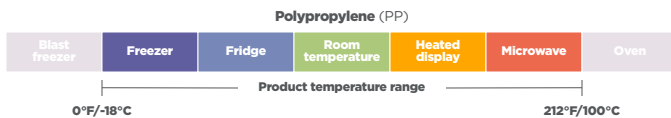

These guidelines are supplied to assist you in determining the proper use of Pactiv Evergreen products. They are based upon testing and published guidelines and are reliable in most applications. However, because every food supplier's recipes, ingredients, processes and supply chain is unique, these guidelines are not a substitute for product testing. Confirmation of product acceptability under your specific conditions of use must be done by you.





Entree2Go™ Two Piece Containers

Designed for delivery! Fill, stack, go! Now with new 8.5 x 8.5" sizes available in black and white bases.



Reduced environmental impact

EarthChoice® mineral filled polypropylene (MFPP) bases are made with 50% less plastic than traditional polypropylene containers, reducing fossil fuel based material usage. The polypropylene lids are recyclable. Check locally; may not be recyclable in all areas.

Keep it crispy

The SmartVent™ system allows steam to release, keeping food hot and crispy even on the go.

Great for to-go

These containers are strong, stackable, and moisture resistant so they can stand up to hearty and saucy foods. The clear lids present menu items beautifully and aids in order identification.

Consumer convenience

Consumers will appreciate that these containers are microwaveable and are safe for top rack use in residential dishwashers.



Entree2Go™ Two Piece Containers

Product specifications

Product number	Brand	Description	Dimensions (in.)	Capacity (oz.)	Material	Color	Case pack
YCNB6X412000	EarthChoice	6 x 4" Entrée2Go 1-compartment container base	5.7 x 4.3 x 2.6	12	MFPP	Black	600
YCNB9X624000	EarthChoice	9 x 6" Entrée2Go 1-compartment shallow container base	8.7 x 5.8 x 2	24	MFPP	Black	300
YCNB9X632000	EarthChoice	9 x 6" Entrée2Go 1-compartment container base	8.7 x 5.8 x 2.7	32	MFPP	Black	300
YCNB85X85351	EarthChoice	8.5 x 8.5" Entrée2Go 1-compartment container base	8.8 x 8.8 x 1.7	35	MFPP	Black	154
YCNB85X85273	EarthChoice	8.5 x 8.5" Entrée2Go 3-compartment container base	8.8 x 8.8 x 1.7	27 (17/5/5)	MFPP	Black	154
YCNB12X94800	EarthChoice	12 x 9" Entrée2Go 1-compartment shallow container base	11.8 x 8.8 x 1.6	48	MFPP	Black	200
YCNB12X96400	EarthChoice	12 x 9" Entrée2Go 1-compartment container base	11.8 x 8.8 x 1.6	64	MFPP	Black	200
YCNB12X95203	EarthChoice	12 x 9" Entrée2Go 3-compartment container base	11.8 x 8.8 x 1.6	52 (28/12/12)	MFPP	Black	200
YCNW85X85351	EarthChoice	8.5 x 8.5" Entrée2Go 1-compartment container base	8.8 x 8.8 x 1.7	35	MFPP	White	154
YCNW85X85273	EarthChoice	8.5 x 8.5" Entrée2Go 3-compartment container base	8.8 x 8.8 x 1.7	27 (17/5/5)	MFPP	White	154
YCNV12X9PPDL	EarthChoice	Vented lid for Entrée2Go 12 x 9" base	11.8 x 8.8 x 1	-	PP	Clear	200
YCNV6X4PPDL	EarthChoice	Vented lid for Entrée2Go 6 x 4" base	5.7 x 4.3 x 1	-	PP	Clear	600
YCNV9X6PPDL	EarthChoice	Vented lid for Entrée2Go 9 x 6" base	8.7 x 5.6 x 1	-	PP	Clear	300
YCNV85X85PPL	EarthChoice	Vented lid for Entrée2Go 8.5 x 8.5" base	8.8 x 8.8 x 1	-	PP	Clear	154

What temperature range is recommended?



Virtual Packaging Assistant

The Virtual Packaging Assistant (VPA) app can be used for all of your Foodservice Packaging Solutions! It is available for download on all Apple, Android and Windows devices.



These guidelines are supplied to assist you in determining the proper use of Pactiv Evergreen products. They are based upon testing and published guidelines and are reliable in most applications. However, because every food supplier's recipes, ingredients, processes and supply chain is unique, these guidelines are not a substitute for product testing. Confirmation of product acceptability under your specific conditions of use must be done by you.





MFPP Hinged Lid Containers

Highly functional, low cost containers great for curbside pickup or delivery.



Reduced environmental impact

EarthChoice® mineral filled polypropylene (MFPP) containers are made with 50% less plastic than traditional polypropylene (PP) containers, reducing fossil fuel based material usage.

Premium performance

These containers are strong, stackable, and moisture resistant so they can stand up to hearty and saucy foods.

Great for to-go

This line helps to maintain temperature and quality to deliver a “same as in-house” dining experience. The SmartLock® closure and perimeter seal prevents messy leaks and spills.

Consumer convenience

Consumers will appreciate that these containers are microwaveable and are safe for top rack use in residential dishwashers.



MFPP Hinged Lid Containers

Product specifications

Product number	Brand	Description	Dimensions (in.)	Material	Color	Case pack
YCN806000000	EarthChoice	6 x 6" 1-Compartment hinged lid container	5.8 x 6 x 3.1	MFPP	White	400
YCN808010000	EarthChoice	8 x 8" 1-Compartment hinged lid container	8.3 x 8.4 x 3.1	MFPP	White	200
YCN808030000	EarthChoice	8 x 8" 3-Compartment hinged lid container	8.3 x 8.4 x 3.1	MFPP	White	200
YCN809010000	EarthChoice	9 x 9" 1-Compartment hinged lid container	9.3 x 8.9 x 3.1	MFPP	White	120
YCN809030000	EarthChoice	9 x 9" 3-Compartment hinged lid container	9.3 x 8.9 x 3.1	MFPP	White	120
YCN809610000	EarthChoice	9 x 6" 1-Compartment hinged lid container	9 x 6 x 3.3	MFPP	White	270
YCN809620000	EarthChoice	9 x 6" 2-Compartment hinged lid container	9 x 6 x 3.3	MFPP	White	270
YCNB060000000	EarthChoice	6 x 6" 1-Compartment hinged lid container	5.8 x 6 x 3.1	MFPP	Black	400
YCNB080100000	EarthChoice	8 x 8" 1-Compartment hinged lid container	8.3 x 8.4 x 3.1	MFPP	Black	200
YCNB080300000	EarthChoice	8 x 8" 3-Compartment hinged lid container	8.3 x 8.4 x 3.1	MFPP	Black	200
YCNB090100000	EarthChoice	9 x 9" 1-Compartment hinged lid container	9.3 x 8.9 x 3.1	MFPP	Black	120
YCNB090300000	EarthChoice	9 x 9" 3-Compartment hinged lid container	9.3 x 8.9 x 3.1	MFPP	Black	120
YCNB809610000	EarthChoice	9 x 6" 1-Compartment hinged lid container	9 x 6 x 3.3	MFPP	Black	270

What temperature range is recommended?

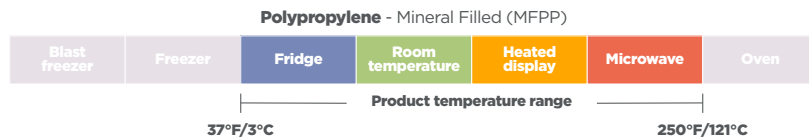

Virtual Packaging Assistant

The Virtual Packaging Assistant (VPA) app can be used for all of your Foodservice Packaging Solutions! It is available for download on all Apple, Android and Windows devices.



These guidelines are supplied to assist you in determining the proper use of Pactiv Evergreen products. They are based upon testing and published guidelines and are reliable in most applications. However, because every food supplier's recipes, ingredients, processes and supply chain is unique, these guidelines are not a substitute for product testing. Confirmation of product acceptability under your specific conditions of use must be done by you.





Mineral Filled Polypropylene **Vented Hinged Lid Containers**

Highly functional low cost containers great for curbside pickup or delivery.



Reduced environmental impact

EarthChoice® mineral filled polypropylene (MFPP) containers are made with 50% less plastic than traditional polypropylene (PP) containers, reducing fossil fuel based material usage.

Great for to-go

This line helps to maintain temperature and quality to deliver a “same as in-house” dining experience. The SmartLock® closure and perimeter seal prevents messy leaks and spills.

Premium performance

These containers are strong, stackable, and moisture resistant so they can stand up to hearty and saucy foods.

Keep it crispy

The SmartVent™ system offered on most sizes allows steam to release, keeping food hot and crispy even on the go.

Consumer convenience

Consumers will appreciate that these containers are microwaveable and are safe for top rack use in residential dishwashers.





Mineral Filled Polypropylene Vented Hinged Lid Containers

Product specifications

Product number	Brand	Description	Dimensions (in.)	Capacity (oz.)	Material	Color	Case pack
YCNW0601	EarthChoice	6 x 6" Vented 1-compartment hinged lid container	6 x 6 x 3.1	16	MFPP	White	400
YCNW0851	EarthChoice	8.5 x 8.5" Vented 1-compartment hinged lid container	8.5 x 8.5 x 3.1	37	MFPP	White	146
YCNW0853	EarthChoice	8.5 x 8.5" Vented 3-compartment hinged lid container	8.5 x 8.5 x 3.1	27	MFPP	White	146
YCNW0207	EarthChoice	9 x 6 " Vented 1-compartment hinged lid container	9 x 6 x 2.75	27	MFPP	White	170
YCNW0205	EarthChoice	9 x 6 " Vented 1-compartment hinged lid container	9 x 6 x 3.1	34	MFPP	White	170
YCNW02052	EarthChoice	9 x 6 " Vented 2-compartment hinged lid container	9 x 6 x 3.1	29	MFPP	White	170

What temperature range is recommended?

Polypropylene - Mineral Filled (MFPP)

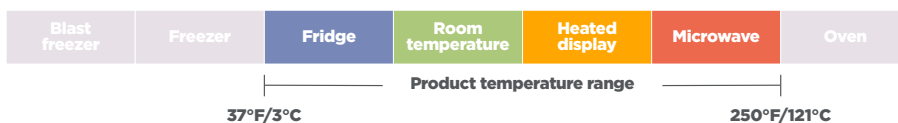

Virtual Packaging Assistant

The Virtual Packaging Assistant (VPA) app can be used for all of your Foodservice Packaging Solutions! It is available for download on all Apple, Android and Windows devices.



These guidelines are supplied to assist you in determining the proper use of Pactiv Evergreen products. They are based upon testing and published guidelines and are reliable in most applications. However, because every food supplier's recipes, ingredients, processes and supply chain is unique, these guidelines are not a substitute for product testing. Confirmation of product acceptability under your specific conditions of use must be done by you.





ClearView® MealMaster® **Two-Piece Containers**

Expertly showcase entrees or side dishes in supermarkets and for takeout



Transport with confidence

Our ZipSeal™ Closure System's leak-resistant seal keeps package contents secure during transport. The easy-to-apply lid has an audible snap indicating the lid has been sealed.

Versatile merchandising

Containers are suitable for both hot and cold applications, reducing operator SKU's and increasing efficiencies. Multiple bases available, ranging from one to three compartments with matching lids.



Superior visibility

Dome lids feature excellent visibility without condensation due to anti-fog technology. For optimal clarity, choose our oriented polystyrene (OPS) domes.

High heat performance

MealMaster two-piece containers are suitable for merchandising in hot case displays, warming units and under heat lamps. MFPP bases and PP lids are also suitable for reheating in a microwave.



MealMaster® Two-Piece Containers Bases



YCN846080000



YCN846120000



OCN846160000



YCN846240000



YCN846320000



OCN846360000



OCN846370000



OCN846380000

Product specifications

Product number	Brand	Description	Dimensions (in.)	Capacity (oz.)	Size* (S, M, L)	Material	Color	Case pack	Case cube (ft³)	Gross case weight (lbs.)
YCN846080000	Pactiv Evergreen	Microwavable container base	6.1 x 4.9 x 1.1	8	S	MFPP	Black	232	1.1	9.0
YCN846120000	Pactiv Evergreen	Microwavable container base	6.1 x 4.9 x 1.6	12	S	MFPP	Black	232	1.2	9.2
OCN846160000	Pactiv Evergreen	Microwavable container base	8.1 x 6.5 x 1	16	M	MFPP	Black	252	2.1	12.4
YCN846240000	Pactiv Evergreen	Microwavable container base	8.1 x 6.5 x 1.5	24	M	MFPP	Black	252	2.2	13.4
YCN846320000	Pactiv Evergreen	Microwavable container base	8.1 x 6.5 x 2	32	M	MFPP	Black	252	2.2	13.7
OCN846360000	Pactiv Evergreen	Microwavable 1-compartment base	9.4 x 8 x 1.5	n/a	L	MFPP	Black	232	3.2	19.4
OCN846370000	Pactiv Evergreen	Microwavable 2-compartment base	9.4 x 8 x 1.5	n/a	L	MFPP	Black	250	3.2	19.4
OCN846380000	Pactiv Evergreen	Microwavable 3-compartment base	9.4 x 8 x 1.5	n/a	L	MFPP	Black	250	3.4	20.2

* Small (S), Medium (M) and Large (L) indicates lids and bases that are compatible.

What temperature range is recommended?

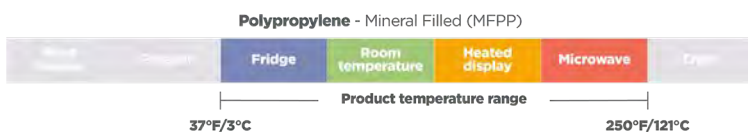



ClearView® MealMaster® Two-Piece Containers Lids



Product specifications

Product number	Brand	Description	Dimensions (in.)	Size* (S, M, L)	Material	Color	Case pack	Case cube (ft³)	Gross case weight (lbs.)
YCN8460H00D0	Pactiv Evergreen	Anti-fog dome lid	6.1 x 4.9 x 1	S	OPS	Clear	232	1.1	4.7
YCN8460H00WV	Pactiv Evergreen	Vented anti-fog dome lid	6.1 x 4.9 x 1	S	OPS	Clear	232	1.2	3.8
YCN8462S00D0	Pactiv Evergreen	Flat anti-fog lid	8.1 x 6.5 x 0.4	M	OPS	Clear	252	2.0	7.8
YCN8462H00D0	Pactiv Evergreen	Anti-fog dome lid	8.1 x 6.5 x 1	M	OPS	Clear	252	2.3	7.9
YCN8462H00WV	Pactiv Evergreen	Vented anti-fog dome lid	8.1 x 6.5 x 1	M	OPS	Clear	252	2.0	7.9
YCN8462HPPD0	EarthChoice	Microwavable dome lid	8.1 x 6.5 x 1	M	PP	Clear	252	2.3	7.6
YCN8466H00D0	Pactiv Evergreen	Anti-fog dome lid	9.4 x 8 x 1.3	L	OPS	Clear	252	3.1	11.3
YCN8467H00D0	Pactiv Evergreen	2-Compartment anti-fog dome lid	9.4 x 8 x 1.3	L	OPS	Clear	252	3.1	11.7
YCN8468H00D0	Pactiv Evergreen	3-Compartment anti-fog dome lid	9.4 x 8 x 1.3	L	OPS	Clear	252	2.9	12.3

* Small (S), Medium (M) and Large (L) indicates lids and bases that are compatible.

What temperature range is recommended?



These guidelines are supplied to assist you in determining the proper use of Pactiv Evergreen products. They are based upon testing and published guidelines and are reliable in most applications. However, because every food supplier's recipes, ingredients, processes and supply chain is unique, these guidelines are not a substitute for product testing. Confirmation of product acceptability under your specific conditions of use must be done by you.





ClearView[®] MealMaster[®] **Two Piece Containers**

A versatile option, ideal for home meal replacement packaging in grocery store hot and cold cases, while also stylish and functional for restaurant takeout and delivery.



Reduced environmental impact

EarthChoice[®] mineral filled polypropylene containers are made with 50% less plastic than traditional polypropylene containers, reducing fossil fuel based material usage. The polypropylene lids are recyclable. Check locally; may not be recyclable in all areas.

Ideal for merchandising and to-go

The stackable lids and bases nest securely to help keep product in place on the shelf and during transportation. The leak-resistant ZipSeal[™] helps to prevent messy spills and maintain food quality. Lids sold separately.

Consumer convenience

Customers enjoy that these containers easily go from refrigerator to microwave and are top-rack dishwasher safe.



ClearView® MealMaster® Two Piece Containers

Product specifications

Product number	Description	Dimensions (in.)	Capacity (oz.)	Material	Color	Case pack	Lid/base match
YCN84612000W	MealMaster containers	6.1 x 4.9 x 1.6	12	MFPP	White	232	YCN8460H00DO
OCN84616000W	MealMaster containers	8.1 x 6.5 x 1	16	MFPP	White	252	YCN8462HPPDO
YCN84624000W	MealMaster containers	8.1 x 6.5 x 1.5	24	MFPP	White	252	YCN8462HPPDO
OCN84637000W	MealMaster 2-compartment containers	9.4 x 8 x 1.5	31	MFPP	White	250	YCN8467H00DO
YCN84632000W	MealMaster containers	8.1 x 6.5 x 2	32	MFPP	White	252	YCN8462HPPDO
YCN8460H00DO	Clearview Dome Lids with Anti-Fog	6.1 X 4.9 X 1	-	OPS	Clear	232	YCN84612000W
YCN8462HPPDO	Dome Lid	8.1 X 6.5 X 1	-	PP	Clear	252	OCN84616000W YCN84624000W YCN84632000W
YCN8467H00DO	Clearview 2-Compartment Dome Lids with Anti-Fog	9.4 X 8 X 1.3	-	OPS	Clear	252	YCN8467H00DO

What temperature range is recommended?

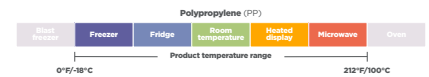
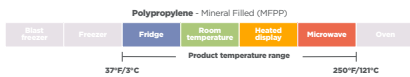

Virtual Packaging Assistant

The Virtual Packaging Assistant (VPA) app can be used for all of your Foodservice Packaging Solutions! It is available for download on all Apple, Android and Windows devices.



These guidelines are supplied to assist you in determining the proper use of Pactiv Evergreen products. They are based upon testing and published guidelines and are reliable in most applications. However, because every food supplier's recipes, ingredients, processes and supply chain is unique, these guidelines are not a substitute for product testing. Confirmation of product acceptability under your specific conditions of use must be done by you.





ClearView® MicroMax®

Two-Piece Oval & Rectangle Containers

Expertly showcase entrees or side dishes in supermarkets and for takeout



Transport with confidence

Our ZipSeal™ Closure System's leak-resistant seal keeps package contents secure during transport. The easy-to-apply lid has an audible snap indicating the lid has been sealed.

Versatile merchandising

Containers are suitable for both hot and cold applications, reducing operator SKUs and increasing efficiencies. Multiple bases available, ranging from one to three compartments with matching lids.



Superior visibility

Dome lids feature excellent visibility without condensation due to anti-fog technology.

High heat performance

MealMaster two-piece containers are suitable for merchandising in hot case displays, warming units and under heat lamps. MFPP bases are also suitable for reheating in a microwave.



ClearView® MicroMax® Oval and Rectangle Containers

Product specifications

Product number	Description	Dimensions (in.)	Size* (S, M, L)	Capacity (oz.)	Material	Color	Case pack	Case cube (ft ³)	Gross case weight (lbs.)
OCN855120000	Microwavable oval casserole container base	7.9 x 5.3 x 2.3	S	12	MFPP	Black	252	1.8	7.8
OCN855160000	Microwavable oval casserole container base	7.9 x 5.3 x 2.5	M	16	MFPP	Black	252	1.8	7.8
YCN8651600D0	Microwavable oval casserole container combo pack	7.9 x 5.3 x 2.8	M	16	MFPP/OPS	Black/Clear	252	2.9	14.2
YCN8550100D0	Oval anti-fog dome for casserole containers	7.9 x 5.3 x 0.3	S, M	n/a	OPS	Clear	252	1.7	6.5
YCN850080000	Microwavable rectangle casserole container base	5.9 x 4.9 x 1.3	S	8	MFPP	Black	252	1.4	6.2
YCN850120000	Microwavable rectangle casserole container base	5.9 x 4.9 x 2.2	S	12	MFPP	Black	252	1.4	7.1
OCN850160000	Microwavable rectangle casserole container base	7.5 x 6.4 x 1.5	M	16	MFPP	Black	252	2.4	11.1
YCN850240000	Microwavable rectangle casserole container base	7.5 x 6.4 x 1.9	M	24	MFPP	Black	252	2.4	11.9
YCN854200000	Microwavable 2-compartment container base	9 x 7.4 x 1.9	L	n/a	MFPP	Black	220	3.0	16.8
YCN854300000	Microwavable 3-compartment container base	9 x 7.4 x 1.9	L	n/a	MFPP	Black	220	2.9	16.8
YCN851000000	Rectangular anti-fog flat lid for casserole containers	5.9 x 4.9	S	n/a	OPS	Clear	252	0.9	3.7
YCN8510100D0	Rectangular anti-fog dome lid for casserole containers	5.9 x 4.9 x 1	S	n/a	OPS	Clear	252	0.8	4.0
YCN8520100D0	Rectangular anti-fog dome lid for casserole containers	7.5 x 6.5 x 1	M, L	n/a	OPS	Clear	252	1.3	7.1
YCN8530100D0	Rectangular anti-fog dome lid for casserole containers	9 x 7.4 x 1	L	n/a	OPS	Clear	220	1.9	8.0

* Small (S), Medium (M) and Large (L) indicates lids and bases that are compatible.

What temperature range is recommended?



These guidelines are supplied to assist you in determining the proper use of Pactiv Evergreen products. They are based upon testing and published guidelines and are reliable in most applications. However, because every food supplier's recipes, ingredients, processes and supply chain is unique, these guidelines are not a substitute for product testing. Confirmation of product acceptability under your specific conditions of use must be done by you.





Newspring™ Containers and Portion Cups

Top of the line in both performance and presentation **VERSA**tainer®, **DEL**tainer®, and **ELLIPSO**® containers are the packaging solutions you need for customer satisfaction and operational excellence.





Quality solutions, that meet your needs

Versatility

Whether you need a quality takeout container for on-the-go entrées or a dynamite deli container for your market, Newspring packaging is offered in a variety of shapes, sizes, and colors for optimal operational versatility.

Premium performance

These sturdy containers are made of heavy-gauge polypropylene. They hold up to your heartiest menu items and will not bend or break when stacked for delivery or display. Bonus for your end customers, Newspring containers are safe for top rack use in residential dishwashers.

Superior leak-resistance

Newspring products have a tight-fitting perimeter seal that provides exceptional leak resistance, so you can store and transport foods with confidence.

High style

Our stylish Newspring packaging presents food beautifully, and their clear lids allow for easy order identification. Choose from a selection of base colors to highlight your cuisine.

Excellent temperature endurance

Ideal for a variety of food applications, both hot and cold, Newspring containers can be stored in the freezer, refrigerated or microwaved.

Newspring™

Containers and Portion Cups

VERSAtainer® Containers and Lids

When you need a container solution that performs and presents, VERSAtainer packaging is the clear choice. This popular line of containers comes in a variety of shapes, sizes, and configurations. These stylish, high-performance containers are a delivery favorite for pasta, stir-fry and other saucy foods.



DELItainer® Containers and Lids

These containers are a versatile option great for deli counters, grab-n-go merchandising and takeout. The lids and bases nest neatly for stacking in retail settings. The secure lid fit keeps the product in place during transportation.

Ellipso® Oval Portion Cups and Lids

Stylish Ellipso portion cups' elegant design enhances the presentation and appeal of condiments and sides. Pour sauces and dressings with ease, due to their unique oval shape.



VERSAtainer®

Containers and Lids

Product specifications

Product #	Description	Dimensions (in.)	Material	Color	Case pack
NC818B	12 oz. Rectangle takeout container and lid combo	4.5 x 5.5 x 2.1	PP	Black/Clear	150
NC818	12 oz. Rectangle takeout container and lid combo	4.5 x 5.5 x 2.1	PP	White/Clear	150
NC8168B	16 oz. Rectangle takeout container and lid combo	5 x 7.3 x 2	PP	Black/Clear	150
NC8168	16 oz. Rectangle takeout container and lid combo	5 x 7.3 x 2	PP	White/Clear	150
NC838B	24 oz. Rectangle takeout container and lid combo	5 x 7.3 x 2.6	PP	Black/Clear	150
NC838	24 oz. Rectangle takeout container and lid combo	5 x 7.3 x 2.6	PP	White/Clear	150
NC868B	28 oz. Rectangle takeout container and lid combo	6 x 8.5 x 2.1	PP	Black/Clear	150
NC868	28 oz. Rectangle takeout container and lid combo	6 x 8.5 x 2.1	PP	White/Clear	150
NC8288B	30 oz. Rectangle 2-compartment takeout container and lid combo	6 x 8.5 x 2.5	PP	Black/Clear	150
NC333B	32 oz. Rectangle 3-compartment takeout container and lid combo	7.5 x 9.9 x 1.8	PP	Black/Clear	150
NC888B	38 oz. Rectangle takeout container and lid combo	6 x 8.5 x 2.6	PP	Black/Clear	150
NC888	38 oz. Rectangle takeout container and lid combo	6 x 8.5 x 2.6	PP	White/Clear	150
NC989B	58 oz. Rectangle takeout container and lid combo	8.5 x 11.5 x 2.5	PP	Black/Clear	150
NC989	58 oz. Rectangle container and lid combo	8.5 x 11.5 x 2.5	PP	White/Clear	150
NC718B	16 oz. Round takeout container and lid combo	6 x 1.5	PP	Black/Clear	150
NC718	16 oz. Round takeout container and lid combo	6 x 1.5	PP	White/Clear	150
NC723B	24 oz. Round takeout container and lid combo	7 x 2.4	PP	Black/Clear	150
NC723	24 oz. Round takeout container and lid combo	7 x 2.4	PP	White/Clear	150
NC729B	32 oz. Round takeout container and lid combo	7 x 2.8	PP	Black/Clear	150
NC729	32 oz. Round takeout container and lid combo	7 x 2.8	PP	White/Clear	150
NC737B	35 oz. Round takeout container and lid combo	8 x 2.5	PP	Black/Clear	150
NC737	35 oz. Round takeout container and lid combo	8 x 2.5	PP	White/Clear	150
NC9388B	39 oz. Round 3-Compartment container and lid combo	9 x 9 x 2.3	PP	Black/Clear	150
NC93881	39 oz. Round 3-Compartment container and lid combo	9 x 2.4	PP	White/Clear	150
NC948B	48 oz. Round takeout container and lid combo	9 x 2.4	PP	Black/Clear	150
NC948	48 oz. Round takeout container and lid combo	9 x 2.4	PP	White/Clear	150
NC718BCONT	16 oz. Round takeout container, bulk	6 x 1.5	PP	Black	300
NC718LID	16 oz. Round takeout lid, bulk	6 x 1.5	PP	Clear	300
OC16B	16 oz. Oval takeout container and lid combo	6.8 x 4.8 x 1.9	PP	Black/Clear	150
OC24B	24 oz. Oval takeout container and lid combo	9.1 x 6.7 x 1.5	PP	Black/Clear	150
OC32B	32 oz. Oval takeout container and lid combo	9.1 x 6.7 x 1.9	PP	Black/Clear	150
OC06B	6 oz. Oval takeout container and lid combo	5.7 x 4.0 x 1.1	PP	Black/Clear	150
OC08B	8 oz. Oval takeout container and lid combo	5.7 x 4.0 x 1.5	PP	Black/Clear	150
NC636B	36 oz. Square takeout container and lid combo	6.75 x 6.8 x 2.6	PP	Black/Clear	150



DELtainer®

Containers and Lids

Product specifications

Product #	Description	Dimensions (in.)	Material	Color	Case pack
YL2508B	8 oz. Round takeout container and lid combo	4.6 x 4.6 x 1.8	PP/PE	Black/Clear	240
YL2508	8 oz. Round takeout container and lid combo	4.6 x 4.6 x 1.8	PP/PE	Clear	240
YL2512	12 oz. Round takeout container and lid combo	4.6 x 4.6 x 2.5	PP/PE	Clear	240
YSD2516B	16 oz. Round takeout container and lid combo	4.6 x 4.6 x 3.1	PP/PE	Black/Clear	240
YSD2516	16 oz. Round takeout container and lid combo	4.6 x 4.6 x 3.1	PP/PE	Clear	240
YL2524	24 oz. Round takeout container and lid combo	4.6 x 4.6 x 4.4	PP/PE	Clear	240
YSD2532	32 oz. Round takeout container and lid combo	4.6 x 4.6 x 5.6	PP/PE	Clear	240
YSD2532B	32 oz. Round takeout container and lid combo	4.6 x 4.6 x 5.6	PP/PE	Black/Clear	240
L8328	32 oz. Squat Round takeout container and lid combo	5.5 x 5.5 x 4.9	PP/PE	Clear	200
L5008Y	8 oz. Round takeout container, bulk	4.6 x 4.6 x 1.8	PP	Clear	480
L5012Y	12 oz. Round takeout container, bulk	4.6 X 4.6 X 2.5	PP	Clear	480
SD5016Y	16 oz. Round takeout container, bulk	4.6 x 4.6 x 3.1	PP	Clear	480
YL5024	24 oz. Round takeout container, bulk	4.6 x 4.6 x 4.4	PP	Clear	480
SD5032Y	32 oz. Round takeout container, bulk	4.6 x 4.6 x 5.6	PP	Clear	480
YNL500	Lid for DELtainer® container	4.6 x 4.6 x 0.4	PE	Clear	480



Ellipso®

Oval Portion Cups and Lids

Product specifications

Product #	Description	Dimensions (in.)	Material	Color	Case pack
YE501	1 oz. Portion cup and lid combo	2.3 x 1.5 x 1.3	PP	Clear	1,000
YE502B	2 oz. Portion cup and lid combo	2.8 x 2 x 1.5	PP	Black/Clear	1,000
YE502	2 oz. Portion cup and lid combo	2.8 x 2 x 1.5	PP	Clear	1,000
E503B	3 oz. Portion cup and lid combo	3.5 x 3.3 x 1.5	PP	Black/Clear	500
E503	3 oz. Portion cup and lid combo	3.5 x 3.3 x 1.5	PP	Clear	500
E504B	4 oz. Portion cup and lid combo	3.5 x 2.3 x 2.1	PP	Black/Clear	500
E504	4 oz. Portion cup and lid combo	3.5 x 2.3 x 2.1	PP	Clear	500
E505B	5 oz. Portion cup and lid combo	3.8 x 2.7 x 2.1	PP	Black/Clear	500
E1001B	1 oz. Portion cup	2.25 x 1.5 x 1.3	PP	Black	1,000
E1002B	2 oz. Portion cup	2.8 x 2 x 1.5	PP	Black	1,000
E1002	2 oz. Portion cup	2.8 x 2 x 1.5	PP	Clear	1,000
E1002LD	Lid for 2 oz. portion cup	2.3 x 1.6 x 0.1	PP	Clear	1,000

What temperature range is recommended?

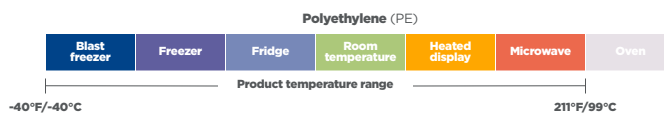
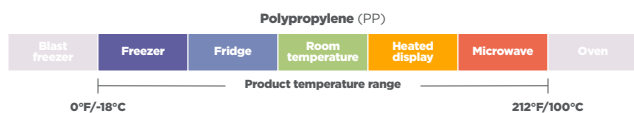

Virtual Packaging Assistant

The Virtual Packaging Assistant (VPA) app can be used for all of your Foodservice Packaging Solutions! It is available for download on all Apple, Android and Windows devices.

These guidelines are supplied to assist you in determining the proper use of Pactiv Evergreen products. They are based upon testing and published guidelines and are reliable in most applications. However, because every food supplier's recipes, ingredients, processes and supply chain is unique, these guidelines are not a substitute for product testing. Confirmation of product acceptability under your specific conditions of use must be done by you.





Polypropylene **Versa2Go™ Containers**

These two piece containers with their clear lids and black matte bases are fantastic for food presentation and delivery performance.



Reduced environmental impact

EarthChoice® Versa2Go™ polypropylene (PP) bases are made with 20% less plastic than our Newspring™ VERSAtainer® bases, reducing fossil fuel based material usage. The PP dome lids are recyclable in the communities that accept these products. Check locally.

Efficient combo pack

Allow bases and lids to ship together in smaller pack quantities and takes up less shelf space.

Great for delivery and to-go

The leak-resistant seal helps to prevent messy spills and maintain food quality, while the stackable lids and bases nest securely to help keep product in place during transportation.

Consumer convenience

Customers enjoy that these containers easily go from refrigerator to microwave and are top-rack dishwasher safe.



Polypropylene Versa2Go™ Containers

Product specifications

Product number	Brand	Description	Dimensions (in.)	Capacity (oz.)	Material	Color	Case pack
NV2GRT2786B	EarthChoice	Versa2Go™ 27 oz. Rectangular container and lid combo	8.4 x 5.6 x 1.4	27	PP	Black/Clear	150
NV2GRT3688B	EarthChoice	Versa2Go™ 36 oz. Rectangular container and lid combo	8.4 x 5.6 x 2	36	PP	Black/Clear	150
NV2GRN237B	EarthChoice	Versa2Go™ 23 oz. Round container and lid combo	6.8 x 6.8 x 1.8	23	PP	Black/Clear	150
NV2GRN307B	EarthChoice	Versa2Go™ 30 oz. Round container and lid combo	6.8 x 6.8 x 2.2	30	PP	Black/Clear	150
NV2GRN469B	EarthChoice	Versa2Go™ 46 oz. Round container and lid combo	9 x 9 x 1.7	46	PP	Black/Clear	150

What temperature range is recommended?

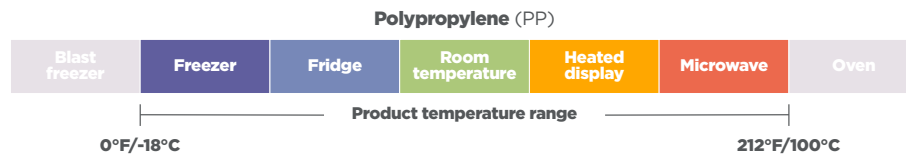

Virtual Packaging Assistant

The Virtual Packaging Assistant (VPA) app can be used for all of your Foodservice Packaging Solutions! It is available for download on all Apple, Android and Windows devices.



These guidelines are supplied to assist you in determining the proper use of Pactiv Evergreen products. They are based upon testing and published guidelines and are reliable in most applications. However, because every food supplier's recipes, ingredients, processes and supply chain is unique, these guidelines are not a substitute for product testing. Confirmation of product acceptability under your specific conditions of use must be done by you.





Aluminum **Classic Carryout Containers**

Attractive, versatile and ovenable, classic carryout containers offer an upscale image for any home meal replacement program.



High Heat Performance

Containers allow food to be prepared, stored, transported and reheated (in the oven) all in the same packaging. Containers are compatible with heat-sealed film.

Transport with Confidence

Heavy-duty, recyclable* aluminum bases protect food and preserve the quality of meats, seafood, prepared entrees, side dishes and bakery foods. Accompanying lids provide a leak-resistant seal.

Versatile Merchandising

Containers are suitable for both hot and cold applications, reducing operator SKUs and increasing efficiencies. Black, gold and silver options are exceptional for displays, increasing visual appeal.



* Check locally; May not be recyclable in all areas



Classic Carryout Containers

Product number	Description	Dimensions (in.)	Capacity (oz.)	Material (base, lid)	Color (base, lid)	Case pack	Case cube (ft ³)
Y6707WPSFG	16 oz. Black & gold base w/ dome lid, combo pack	7.5625 x 5.25 x 1.3125	16	Aluminum, OPS	Black & Gold, Clear	100	0.9
34955APTDB	16 oz. Black & gold base w/ dome lid, combo pack	7.5625 x 5.25 x 1.3125	16	Aluminum, OPS	Black & Gold, Clear	100	0.9
6708WPZFG	22 oz. Black & gold base w/ dome lid, combo pack	8.1875 x 6.1875 x 1.25	22	Aluminum, OPS	Black & Gold, Clear	100	1.3
6708WPSFG	22 oz. Black & gold base w/ dome lid, combo pack	8.1875 x 6.1875 x 1.25	22	Aluminum, OPS	Black & Gold, Clear	100	1.3
6708KWPS	22 oz. Black & silver base w/ dome lid, combo pack	8.1875 x 6.1875 x 1.25	22	Aluminum, OPS	Black & Silver, Clear	100	1.3
Y6708KWPET	22 oz. Black & gold base w/ dome lid, combo pack	8.1875 x 6.1875 x 1.25	22	Aluminum, PET	Black & Gold, Clear	100	1.3
Y670855EDK	22 oz. Black & gold base w/ dome lid, combo pack	8.1875 x 6.1875 x 1.25	22	Aluminum, OPS	Black & Gold, Clear	250	1.1
Y6708PET	22 oz. Silver base w/ dome lid, combo pack	8.1875 x 6.1875 x 1.25	22	Aluminum, PET	Silver, Clear	100	1.3
Y6708PLAT	22 oz. Silver base, bulk pack	8.1875 x 6.1875 x 1.25	22	Aluminum	Silver	150	0.7
Y6710PET	46 oz. Silver base w/ dome lid, combo pack	9.75 x 7.75 x 1.75	46	Aluminum, PET	Silver, Clear	50	1.1
Y6710KWPET	46 oz. Black & gold base w/ dome lid, combo pack	9.75 x 7.75 x 1.75	46	Aluminum, PET	Black & Gold, Clear	50	1.1
Y6710WPZFG	46 oz. Black & gold base w/ dome lid, combo pack	9.75 x 7.75 x 1.75	46	Aluminum, OPS	Black & Gold, Clear	50	1.1
6710KWPZ	46 oz. Black & silver base w/ flat lid, combo pack	9.75 x 7.75 x 1.75	46	Aluminum, OPS	Black & Silver, Clear	50	1.1
Y6710WPSFG	46 oz. Black & gold base w/ dome lid, combo pack	9.75 x 7.75 x 1.75	46	Aluminum, OPS	Black & Gold, Clear	50	1.1
6710KWPS	46 oz. Black & silver base w/ dome lid, combo pack	9.75 x 7.75 x 1.75	46	Aluminum, OPS	Black & Silver, Clear	50	1.1
Y6711PET	60 oz. Black & silver base w/ dome lid, combo pack	11.25 x 8.875 x 1.75	60	Aluminum, PET	Silver, Clear	50	1.4
6711WP	60 oz. Black & gold base w/ dome lid, combo pack	11.25 x 8.875 x 1.75	60	Aluminum, OPS	Black & Gold, Clear	50	1.4
Y6711PLAT	60 oz. Silver base, bulk pack	11.25 x 8.875 x 1.75	60	Aluminum	Silver	100	1.0
6713WPTE	72 oz. Silver base w/ tamper-evident dome lid, combo pack	12.25 x 7.5 x 3.1	72	Aluminum, PET	Silver, Clear	125	4.2

What temperature range is recommended?

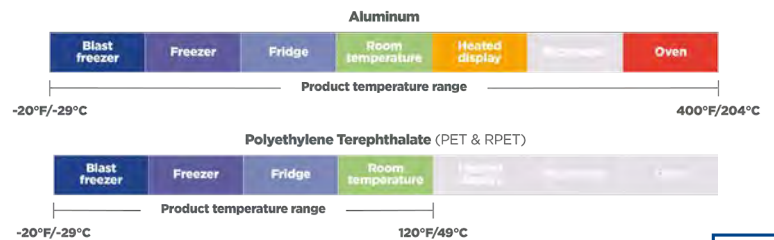
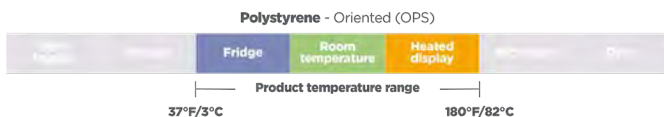

These guidelines are supplied to assist you in determining the proper use of Pactiv Evergreen products. They are based upon testing and published guidelines and are reliable in most applications. However, because every food supplier's recipes, ingredients, processes and supply chain is unique, these guidelines are not a substitute for product testing. Confirmation of product acceptability under your specific conditions of use must be done by you.



pactiv 
evergreen

**Pressware®
Dual Ovenable
Paperboard Containers**



Whether it's sweet or savory, individual or family size, Pactiv Evergreen has a variety of colors and sizes for your ovenable applications. Customizable options available to cater to your processing needs.



VPA™

Virtual Packaging Assistant (VPA)

The NEW App for all your Foodservice Packaging Solutions!
Available Now for your Apple, Android and Windows Device.

Powered by  **pactiv evergreen**



pactiv 
evergreen

pactiv.com | earthchoicepackaging.com

Features	Benefits
Dual Ovenable Paperboard	Can be used in microwave or conventional oven at temperatures up to 400°F for 60 minutes.
Versatile	Pressware trays hold a variety of food applications either hot or cold. They can be stored in the freezer or refrigerator without cracking or denting.
Serving Tray Appeal	Upscale structural design along with color and graphic capabilities offer excellent merchandising opportunities for high visual impact.
Variety of Sizes	Pressware trays hold food products from family sized entrees to portion-controlled entrees, side dishes and desserts.
Two Closure Options	Clear OPS Dome lids or peel-able film.
Rounded Radius Corners	In the microwave oven, heating is enhanced because Pressware trays are transparent to microwave energy and cooking hot spot areas are reduced with Presswares rounded radius corners and bottoms (on some trays).
Flanges	Provides ease of handling and enhanced rigidity. A flat, even heat resealable surface.

Rectangles and Squares

Pressware containers are available in a variety of shapes sizes and colors for most any application you can think of hot or cold.



Round Bowls

From sweet to savory recipies, Pressware® Round Bowls are your dual-ovenable solution!



Pizza

Food preparation, cooking, baking and serving directly on the same tray.

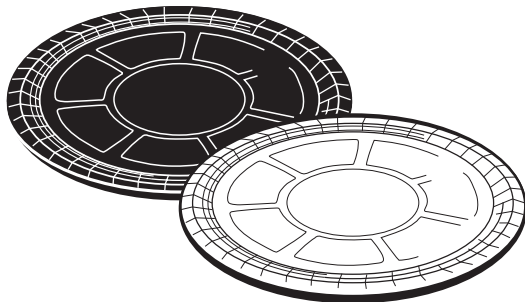

Features Benefits

Exceptional Temperature Endurance	Temperatures ranging from -40°F up to 450°F for 30 minutes* in conventional oven or reheat in microwave oven.
Dual Ovenable Paperboard	Provides a cut resistant surface for food preparation, cooking, baking and serving directly on the same tray.
Versatile	Can be stored in freezer or refrigerated without cracking or denting.
Variety of Sizes	Allows for a variety of food applications, from family-sized pizzas to individual personal pan.
Closure Options	Film sealable (before baking).
Rounded Radius Corners	Enhance heating and reduce hot-spot areas for more even cooking in a microwave oven.

- Dual-ovenable food containers
- Take-n-Bake Pizza Trays
- Quick Serve Restaurant
- Microwave active packaging
- PET Coated paperboard Trays
- PET Color: Clear, Black, White
- Paperboard Calipers: 16 to 29 points
- Exterior: Almost any print desired (solid, random, registered)

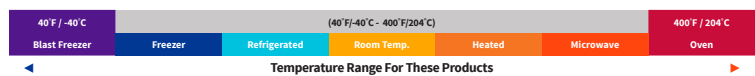

These guidelines are supplied to assist you in determining the proper use of Pactiv Evergreen products. They are based upon testing and published guidelines and are reliable in most applications. However, because every food supplier's recipes, ingredients, processes and supply chain is unique, these guidelines are not a substitute for product testing. Confirmation of product acceptability under your specific conditions of use must be done by you.



PIZZA

Base Number	Capacity (fl.oz.)	Top Out Width (in.)	Top In Width (in.)	Bottom Out Width (in.)	Bottom Out Length (in.)	Vertical Depth (in.)	Case Pack
01305	38.0	13.156"	13.156"	11.938"	11.938"	0.594"	250
01505	52.0	15.468"	15.468"	14.188"	14.188"	0.594"	250
0806	18.0	8.25"	8.25"	7.00"	7.00"	0.812"	350

*Available in ebony, white, speckled and custom colors; Ask your sales representative

**Available as Made to order (MTO) Ask your sales rep. for minimum run information

ROUNDS**

Base Number	Capacity (fl.oz.)	Top Out Width (in.)	Top In Width (in.)	Bottom Out Width (in.)	Bottom Out Length (in.)	Vertical Depth (in.)	Case Pack
0406	3.0	4.000	4.000	2.719	2.719	0.750	2520
0511	6.9	5.094	5.094	3	3	1.125	2000
0615	16.6	6.344	6.344	4.156	4.156	1.625	500

SQUARE

Base Number	Capacity (fl.oz.)	Top Out Width (in.)	Top In Width (in.)	Bottom Out Width (in.)	Bottom Out Length (in.)	Vertical Depth (in.)	Case Pack
4403	3.5	4.312"	4.312"	4.031"	4.031"	0.375"	300
4412	6.4	4.188"	4.188"	2.750"	2.750"	1.25"	1000
4413	9.5	4.625"	4.625"	3.094"	3.094"	1.375"	1000
8812R	35.5	7.938"	7.938"	6.625"	6.625"	1.312	250

RECTANGLE

Base Number	Capacity (fl.oz.)	Top Out Width (in.)	Top In Width (in.)	Bottom Out Width (in.)	Bottom Out Length (in.)	Vertical Depth (in.)	Case Pack
5611R	13.8	4.906	6.531	3.781	5.281	1.125	900
5613R	14.5	4.906	6.531	3.500	5.000	1.375	500
5615	16.8	4.875	6.094	3.188	4.312	1.688	500
5617-21	21.0	5.5156	6.562	3.594	4.938	1.875	500
5713-21	20.8	5.062	7.750	3.625	6.312	1.375	500
5713R	21.3	5.438	7.469	4.094	6.000	1.375	500
5811R	20.5	5.938	8.281	4.781	7.000	1.125	500
6812-31	26.9	6.594	8.688	5.281	7.281	1.250	260
6815	35.7	6.750	8.906	5.125	7.062	1.625	250
6816	32.0	6.000	7.875	4.250	6.125	1.750	500
6821	43.4	6.594	8.750	4.781	6.719	2.125	250
7014	45.0	7.469	9.969	6.000	8.312	1.500	250
7106	23.0	7.250	11.312	6.375	10.375	0.719	500
7917	47.0	7.125	9.188	5.344	7.188	1.938	1536
81216	64.0	8.625	12.125	6.344	9.719	1.750	945
8812	35.5	7.812	7.938	6.625	6.562	1.312	250
91121	82.5	8.938	11.406	7.031	9.406	2.062	600





To learn more about our wide range of food packaging, foodservice and sustainable products, contact your sales representative today.

These guidelines are supplied to assist you in determining the proper use of Pactiv Evergreen products. They are based upon testing and published guidelines and are reliable in most applications. However, because every food supplier's recipes, ingredients, processes and supply chain is unique, these guidelines are not a substitute for product testing. Confirmation of product acceptability under your specific conditions of use must be done by you.

